

Donna 1

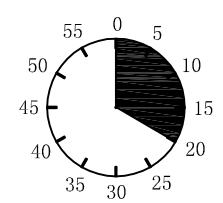
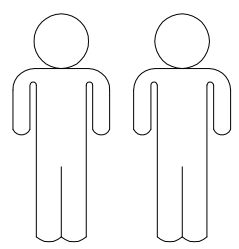
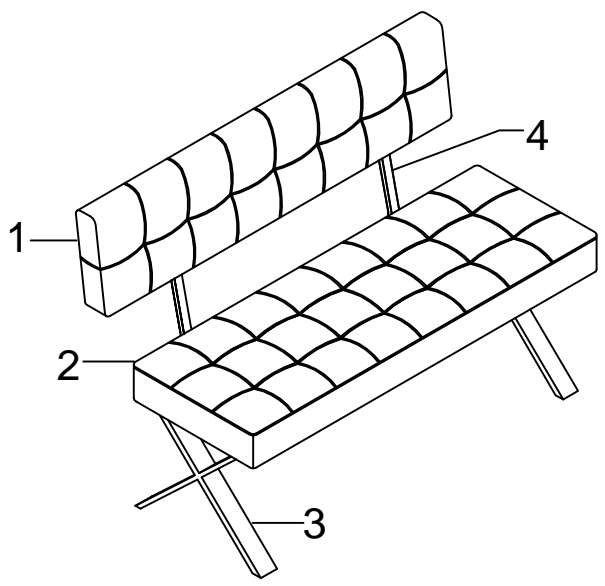

1

2

3

4

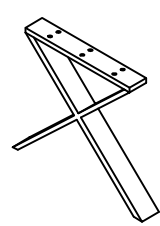
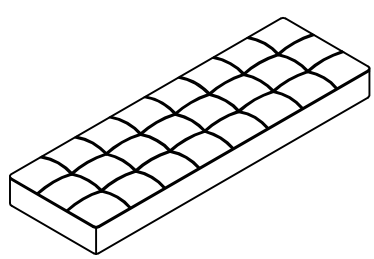
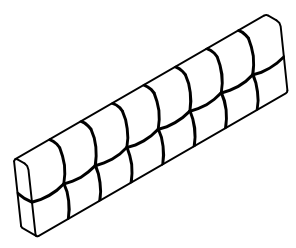

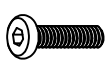

1	1X
2	1X
3	2X
4	2X

A M8*35

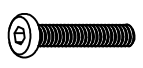
 16X

B M8*15

 4X

C M8*45

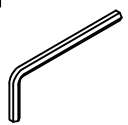
 2X

D Ø18*Ø8*1.5

 22X



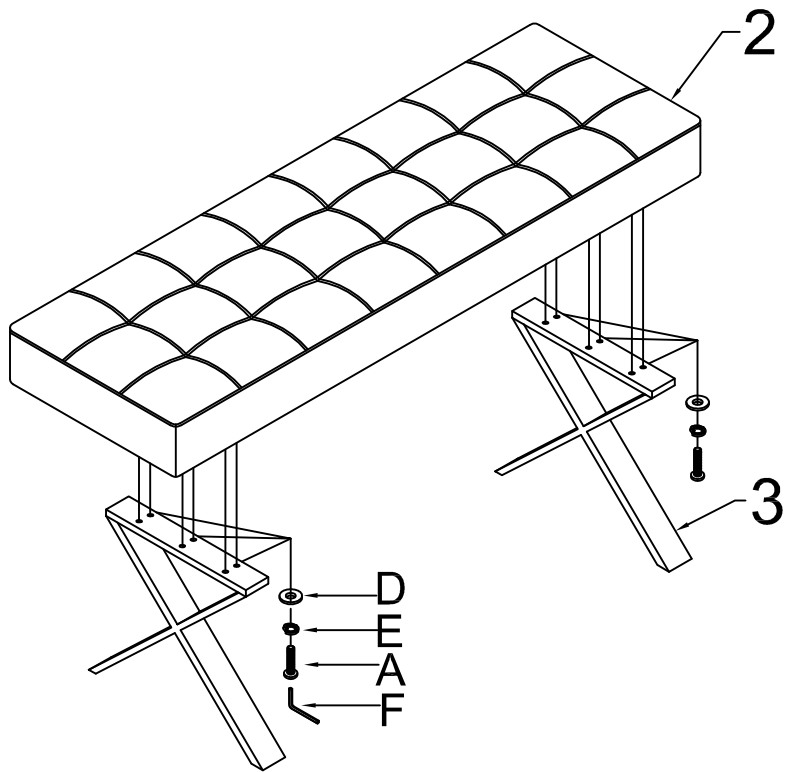

E M8

 22X

F 5mm

 1X

I.



1.

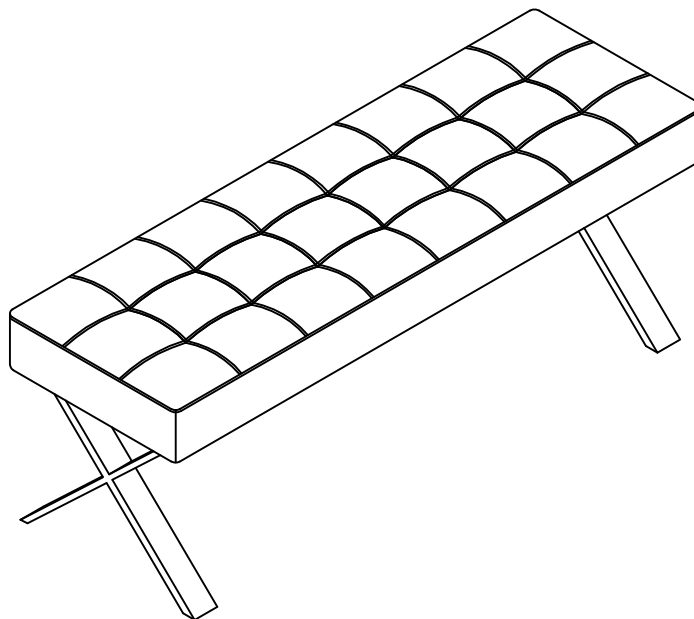

A	 M8*35 12X
D	 Ø18*Ø8*1.5 12X
E	 M8 12X
F	 5mm 1X
	

2.





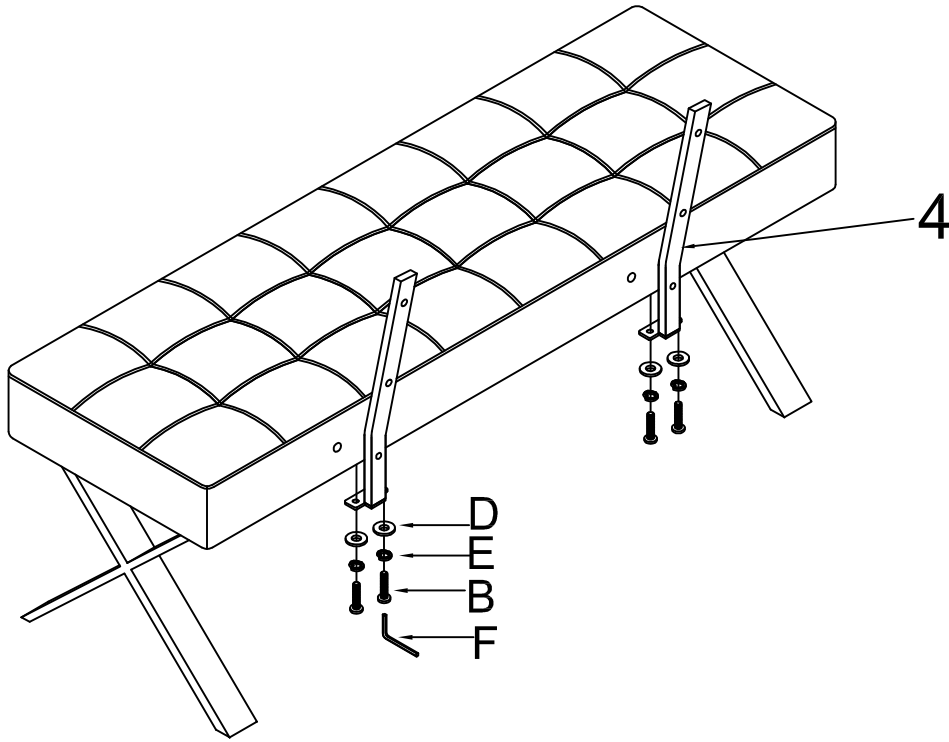

F	 5mm 1X
	

II.





3.

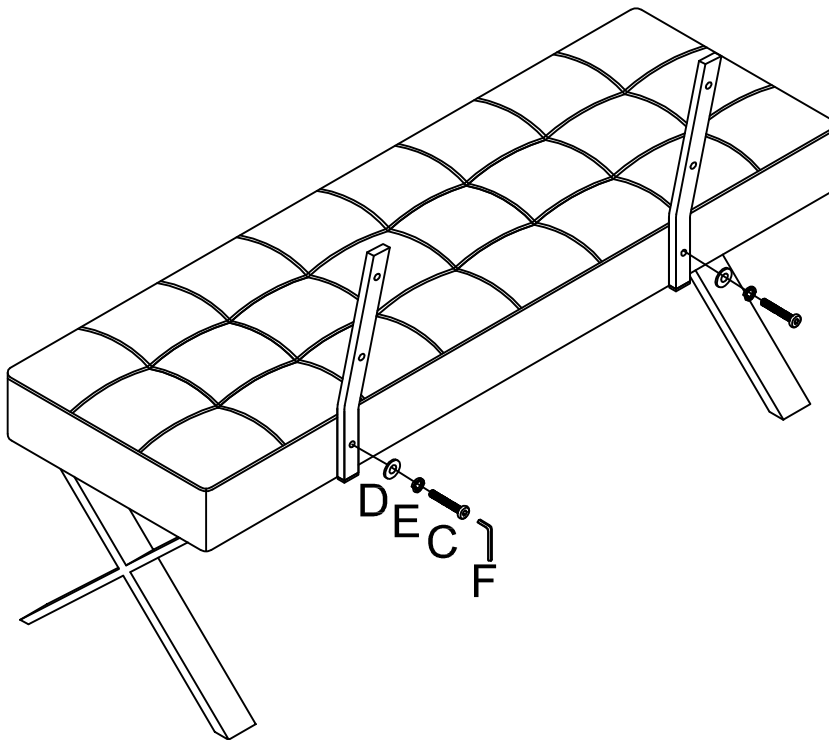

B	M8*15		4X
D	Ø18*Ø8*1.5		4X
E	M8		4X
F	5mm		1X
			

4.





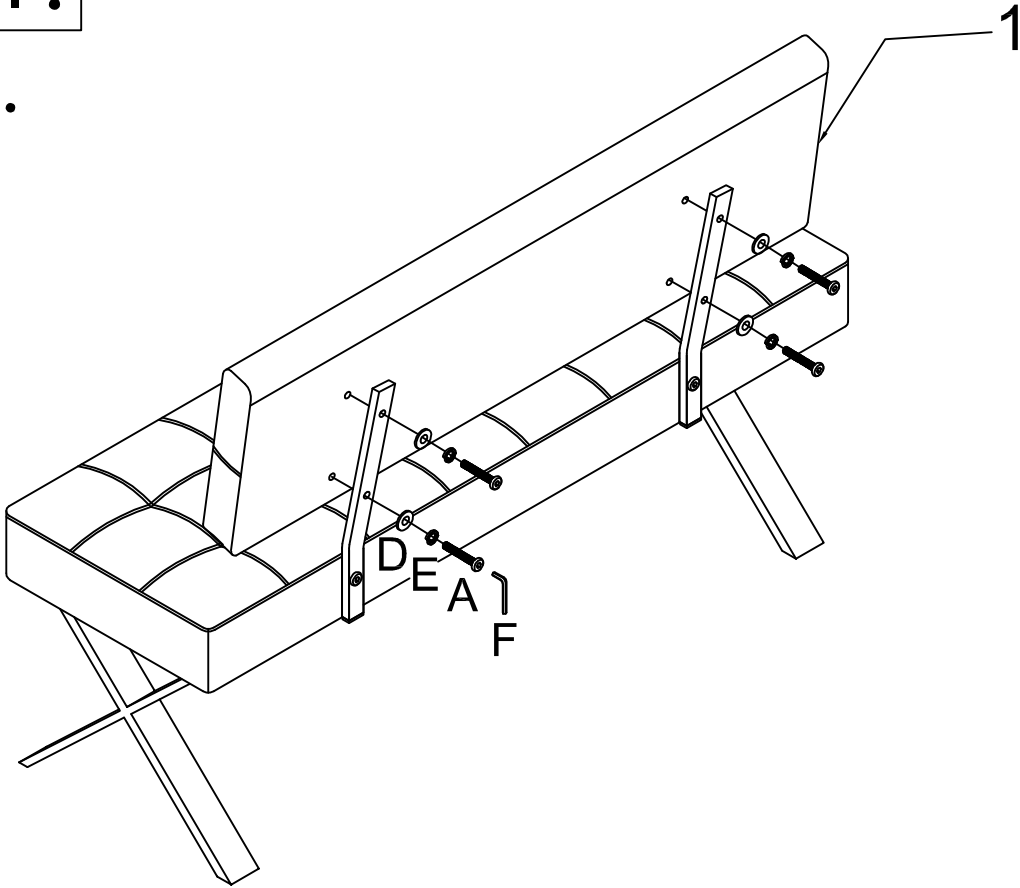

C	M8*45		2X
D	Ø18*Ø8*1.5		2X
E	M8		2X
F	5mm		1X
			

III.

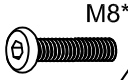
5.

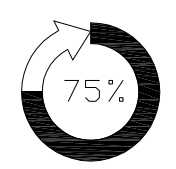

- A  M8*35
4X
 - D  Ø18*Ø8*1.5
4X
 - E  M8
4X
 - F  5mm
1X
- 

75%

6.

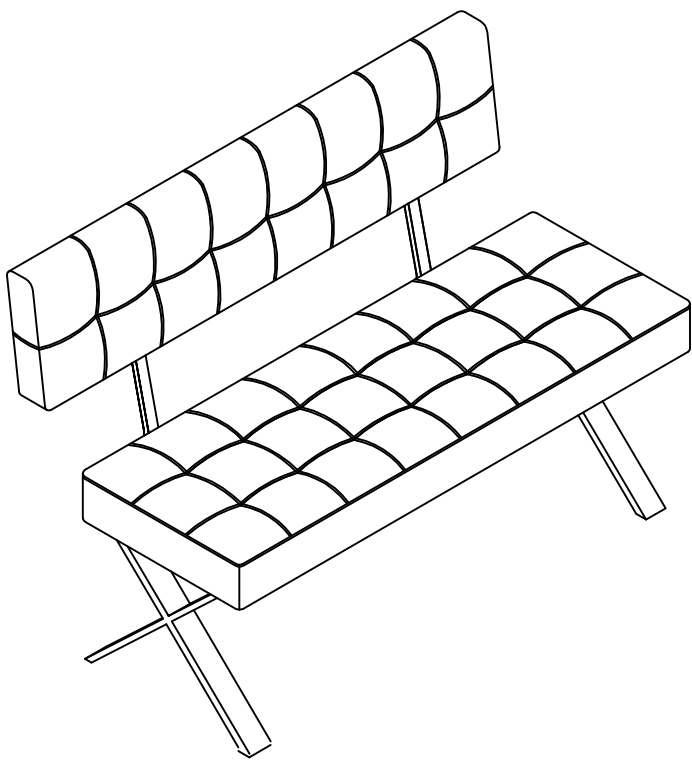

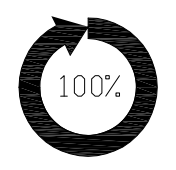
- F  5mm
1X
- 

100%

